

1E4053 | DART Round Maxi RGBW

Professional adjustable LED projector

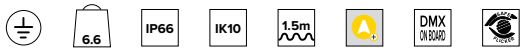

The fixture's photometric values can be found on the following pages

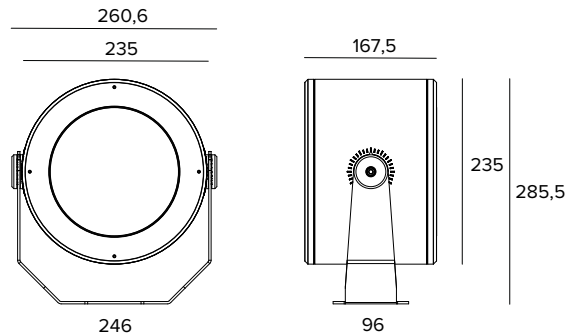

The figures on the drawing are expressed in mm.

SOURCE

RGBW light module made of RGBW LED multichip. Color temperature of the white source: 6500K.

Energy efficiency class: F

Nominal power: 45W

Nominal flux: See photometries

Colour rendering index: See photometries

CCT nominal: See photometries

Lifetime (L80/B10): >50000h tq +25°C

ILLUMINOTECHNICAL CHARACTERISTICS

Equipped with precision methacrylate lenses and spreader filter.

Optic: LENSES

Beam angles: FL

Optical efficiency: 73%

Fixture flux: See photometries

Luminous efficacy: See photometries

Photobiological safety: Compliant with RG1 low risk group

MECHANICAL CHARACTERISTICS

Painted die-cast anodised aluminium body and painted stainless steel mounting bracket. Tempered extra clear front glass.

Colour and finish: Ferrite

Weight: 6.6Kg

Degree of protection: IP66

Mechanical Resistance: IK10

ELECTRICAL CHARACTERISTICS

Electronic DMX-RDM driver integrated in the body of the fixture with 4 independent constant current outputs. Controlled using DMX-RDM protocols that make it possible to programme the fixture remotely (no dip-switch) using the DMX data line. Programming the fixtures is done using the USB-RDM programmer that is available as an accessory. All versions are pre-wired with a 1.5m long cable for power supply and DMX signal. Luminaire compliant with EN 60598-2-22 for power supply from a centralised emergency system CPSS (Central Power Supply System), not incorporated in the luminaire - high risk areas excluded. The default power and flux are 100% in AC and 100% in DC.

Fixture Power: See photometries

Power supply: 220-240Vac 50/60Hz

Insulation Class: CLASS 1

Type of driver / Control: DMX RDM

Driver included: YES

SAFE FLICKER: PstLM=<1 and SVM=<0.4 (IEC TR 61547-1 and IEC TR 63158), to ensure a more comfortable and safe light

Ambient temperature: -25°C / +35°C

INSTALLATION

Mounting bracket with aiming adjustability. Adjustable up to $\pm 45^\circ$ on the horizontal plane and $+90^\circ/-45^\circ$ on the vertical plane.

NOTES

Uses the "Waterblock Smart" technical solution that involves resin coating the connection cables, limiting the risk of humidity reaching the driver or the fixture. It is possible to subject the product to Cataphoresis treatment on request. 110-277Vac version available on request. Photometries show the maximum emission values of fixtures. Commissioning of the control system via free APP; the intervention of a specialist technician can be quoted on request.

WARRANTY

5 years.

WARNING

Luminaire designed for disposal/recycling at end-of-life. Replaceable (LED only) light source by a professional. Replaceable control gear by a professional.

Due to the technological evolution of the electronic components, the data provided may be updated, and as such, confirmation must be requested during the order process.

Luminous flux and power supply have +/-10% tolerances with respect to the indicated value. tq +25°C (CIE 121).

We reserve the right to make technical changes.

Targetti Sankey S.r.l.
Via Pratese, 164
50145 Firenze - Italy
Tel: +39 055 37911
targetti.com
targetti@targetti.com

CCIAA Firenze
Share Capital:
€ 500.000,00
VAT N. (IT):
01537660480
R.E.A: FI-275656

TARGETTI

1E4053 | DART Round Maxi RGBW

Professional adjustable LED projector



		H(m)	D(m)	E _{max} (lx)		
	-		30°			
Fixture Power	50W	1	0.54	6198		
Source Flux	2753lm	2	1.08	1549		
Fixture Flux	2007lm	3	1.62	689		
Efficacy	40lm/W	4	2.16	387		
TS1785	I _{max} =2251cd/klm	I _{max}	6198cd	5	2.70	248



		H(m)	D(m)	E _{max} (lx)		
	-		30°			
Fixture Power	37W	1	0.54	3404		
Source Flux	1512lm	2	1.08	851		
Fixture Flux	1102lm	3	1.62	378		
Efficacy	30lm/W	4	2.16	213		
TS1785	I _{max} =2251cd/klm	I _{max}	3404cd	5	2.70	136

RGBW

Fixture Power	50W
Nominal flux	2753lm
Fixture flux	2007lm
Luminous efficacy	40lm/W

RGB

Fixture Power	37W
Nominal flux	1512lm
Fixture flux	1102lm
Luminous efficacy	30lm/W

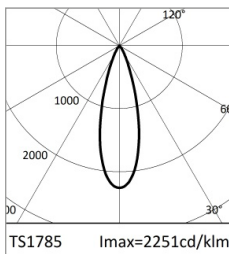

	6500K	H(m)	D(m)	E _{max} (lx)		
	Ra80		30°			
Fixture Power	13W	1	0.54	2990		
Source Flux	1328lm	2	1.08	747		
Fixture Flux	968lm	3	1.62	332		
Efficacy	73lm/W	4	2.16	187		
TS1785	I _{max} =2251cd/klm	I _{max}	2990cd	5	2.70	120



		H(m)	D(m)	E _{max} (lx)		
	-		30°			
Fixture Power	9W	1	0.54	1015		
Source Flux	451lm	2	1.08	254		
Fixture Flux	329lm	3	1.62	113		
Efficacy	35lm/W	4	2.16	63		
TS1785	I _{max} =2251cd/klm	I _{max}	1015cd	5	2.70	41

WHITE

CCT nominal	6500K
Colour rendering index	80
Fixture Power	13W
Nominal flux	1328lm
Fixture flux	968lm
Luminous efficacy	73lm/W

RED

Fixture Power	9W
Nominal flux	451lm
Fixture flux	329lm
Luminous efficacy	35lm/W

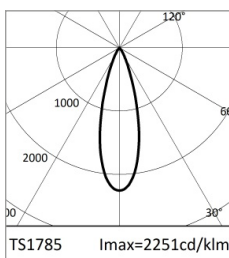

		H(m)	D(m)	E _{max} (lx)		
	-		30°			
Fixture Power	15W	1	0.54	2258		
Source Flux	1003lm	2	1.08	564		
Fixture Flux	731lm	3	1.62	251		
Efficacy	49lm/W	4	2.16	141		
TS1785	I _{max} =2251cd/klm	I _{max}	2258cd	5	2.70	90

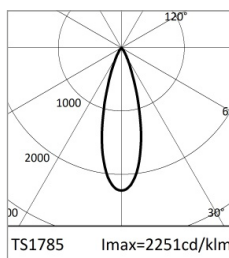

		H(m)	D(m)	E _{max} (lx)		
	-		30°			
Fixture Power	12W	1	0.54	369		
Source Flux	164lm	2	1.08	92		
Fixture Flux	120lm	3	1.62	41		
Efficacy	10lm/W	4	2.16	23		
TS1785	I _{max} =2251cd/klm	I _{max}	369cd	5	2.70	15

GREEN

Fixture Power	15W
Nominal flux	1003lm
Fixture flux	731lm
Luminous efficacy	49lm/W

BLUE

Fixture Power	12W
Nominal flux	164lm
Fixture flux	120lm
Luminous efficacy	10lm/W

Due to the technological evolution of the electronic components, the data provided may be updated, and as such, confirmation must be requested during the order process. Luminous flux and power supply have +/-10% tolerances with respect to the indicated value. tq +25°C (CIE 121).

We reserve the right to make technical changes.

Targetti Sankey S.r.l.
Via Pratese, 164
50145 Firenze - Italy
Tel: +39 055 37911
targetti.com
targetti@targetti.com

CCIAA Firenze
Share Capital:
€ 500.000,00
VAT N. (IT):
01537660480
R.E.A: FI-275656



1E4053 | DART Round Maxi RGBW

Professional adjustable LED projector

Accessories

Filter



Colour	Code
	1E4010

Blade of light filter.
PMMA holographic filter for a blade of light effect.
Completed with powder coated aluminum alloy holder ring.

Grid

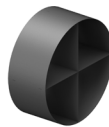

Colour	Code
	1E4013

Anti-glare louver.
Powder coated stainless steel.

Screen



Colour	Code
	1E4011

Asymmetric screen.
Powder coated stainless steel.



Colour	Code
	1E4012

Cylindrical screen.
Powder coated stainless steel.
Short version.

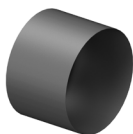

Colour	Code
	1E4059

Cylindrical screen.
Powder coated stainless steel.
Long version.

Mounting System



Colour	Code
	1E3026

Plate for fixture rotation.
Powder coated stainless steel.



Dimensions ØxH mm	Colour	Code
150x352		1E3188

Earthspike.
Powder coated stainless steel.

Due to the technological evolution of the electronic components, the data provided may be updated, and as such, confirmation must be requested during the order process.
Luminous flux and power supply have +/-10% tolerances with respect to the indicated value. tq +25°C (CIE 121).

We reserve the right to make technical changes.

Targetti Sankey S.r.l.
Via Pratese, 164
50145 Firenze - Italy
Tel: +39 055 37911
targetti.com
targetti@targetti.com

CCIAA Firenze
Share Capital:
€ 500.000,00
VAT N. (IT):
01537660480
R.E.A: FI-275656

TARGETTI

1E4053 | DART Round Maxi RGBW Professional adjustable LED projector

Mounting System



Colour Code

● **1E2825**

Pole bracket.
Anodised and powder coated aluminium.
Pole Ø 60mm (+/-2mm).



Colour Code

● **1E3097**

Pole multiple mounting system.
Powder coated stainless steel.
To be completed with 1E2825.
Max 4 projectors.

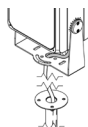

Colour Code

● **1E3187**

Pole with base.
Powder coated stainless steel.

Control systems



Code

1E2767

USB-RDM Programmer code.
DMX-RDM (Remote Device Management) address planner.
Used with the "RDM Targetti" software that can be downloaded for free from the Targetti website download section.
To be used with all RGBW products.
The USB-RDM programmer manages to direct DMX-RDM fixtures if there are no BUFFER or Splitter DMXs on the section.
Please refer to the instructions for more details.



Code

A077

my-SCENARIO Show Store.
Programmable DMX interface that integrates the latest innovations in lighting control in architectural and entertainment applications.
It features USB Type-C and Ethernet ports for programming and remote control.
The unit can be fully programmed with ESA Pro 2 software (available for Windows and Mac users) or via mobile applications such as Arcolis (available for iOS or Android devices).
It can be fully customised: pixel mapping, triggering management, patch configuration and much more.
The system offers great possibilities for the control of your lighting installation: multi zone control (allowing the management of up to 5 independent zones), extended triggers (time/date, Sunrise/Sunset, input ports, TCP/UDP commands), 16-bit channels management, full recovery after power loss, up to 99 total scenes, and 1024+ DMX channels.
The intuitive backlit keyboard comes with 10 preset buttons for a user friendly experience.

*Due to the technological evolution of the electronic components, the data provided may be updated, and as such, confirmation must be requested during the order process.
Luminous flux and power supply have +/-10% tolerances with respect to the indicated value. tq +25°C (CIE 121).*

We reserve the right to make technical changes.

Targetti Sankey S.r.l.
Via Pratese, 164
50145 Firenze - Italy
Tel: +39 055 37911
targetti.com
targetti@targetti.com

CCIAA Firenze
Share Capital:
€ 500.000,00
VAT N. (IT):
01537660480
R.E.A: FI-275656



1E4053 | DART Round Maxi RGBW Professional adjustable LED projector

Control systems



Code

1T6499

myScenario Wall.

DMX controller with a glass touch sensitive screen for architectural applications.

It can control two different DMX universes (2x 512 channels).

Stand alone function or connected to a computer using a USB port.

Software for creating scenarios (that can be downloaded from the Targetti website) included.

It can manage 10 different lighting zones and 50 scenarios per zone.

The touch keys on the front make it possible to modify and recall programmed scenarios.

USB cable included.

To be used with all RGBW products.

Surge protector

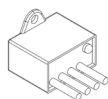

Code

A013A

Surge protector compatible with CLASS I lighting fixtures.

Operating voltage 230-277Vac.

SPD type 2+3.

Max surge protection 10kV.

CLASS I

IP67

Due to the technological evolution of the electronic components, the data provided may be updated, and as such, confirmation must be requested during the order process.

Luminous flux and power supply have +/-10% tolerances with respect to the indicated value. tq +25°C (CIE 121).

We reserve the right to make technical changes.

Targetti Sankey S.r.l.
Via Pratese, 164
50145 Firenze - Italy
Tel: +39 055 37911
targetti.com
targetti@targetti.com

CCIAA Firenze
Share Capital:
€ 500.000,00
VAT N. (IT):
01537660480
R.E.A: FI-275656

TARGETTI